

## **Q: What is a metered dose inhaler or dry powder inhaler?**

**These are also known as a puffer or a spray.**

Metered-dose inhalers (MDI) deliver medicines in a spray or dry powder into the lungs when you press the inhaler and breathe in.

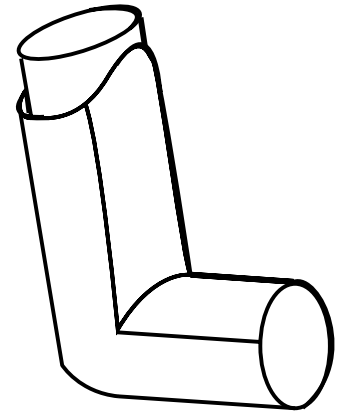

## **Q: What is a spacer?**

A spacer or holding chamber attaches to your inhaler. It increases the amount of medicine going into the lungs and decreases the amount left in your mouth. Rinse your holding chamber with warm soapy water and let it dry completely.

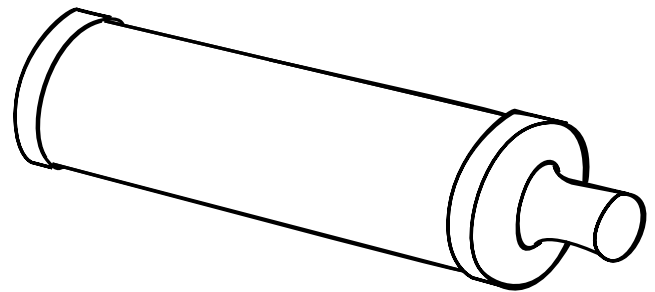

## **Q: What is a dry powder inhaler?**

A dry powder inhaler (DPI) is a device that gives the medicine in a powder form instead of a mist or spray.

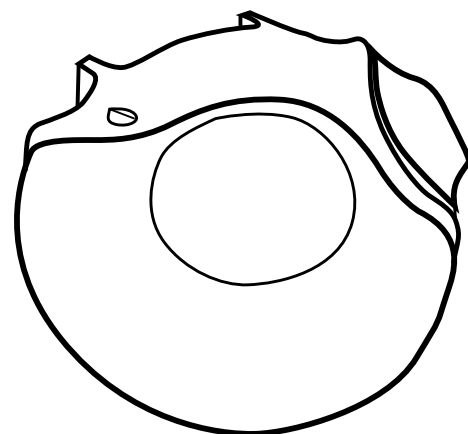

# INHALER MAZE — COLOR THE INHALERS/SPACERS THAT TAKE YOU TO YOUR PERSONAL BEST...

start at the “X” and find your way.

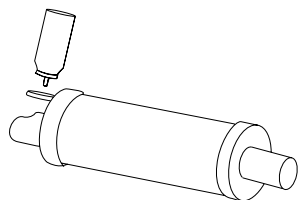
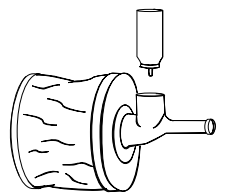
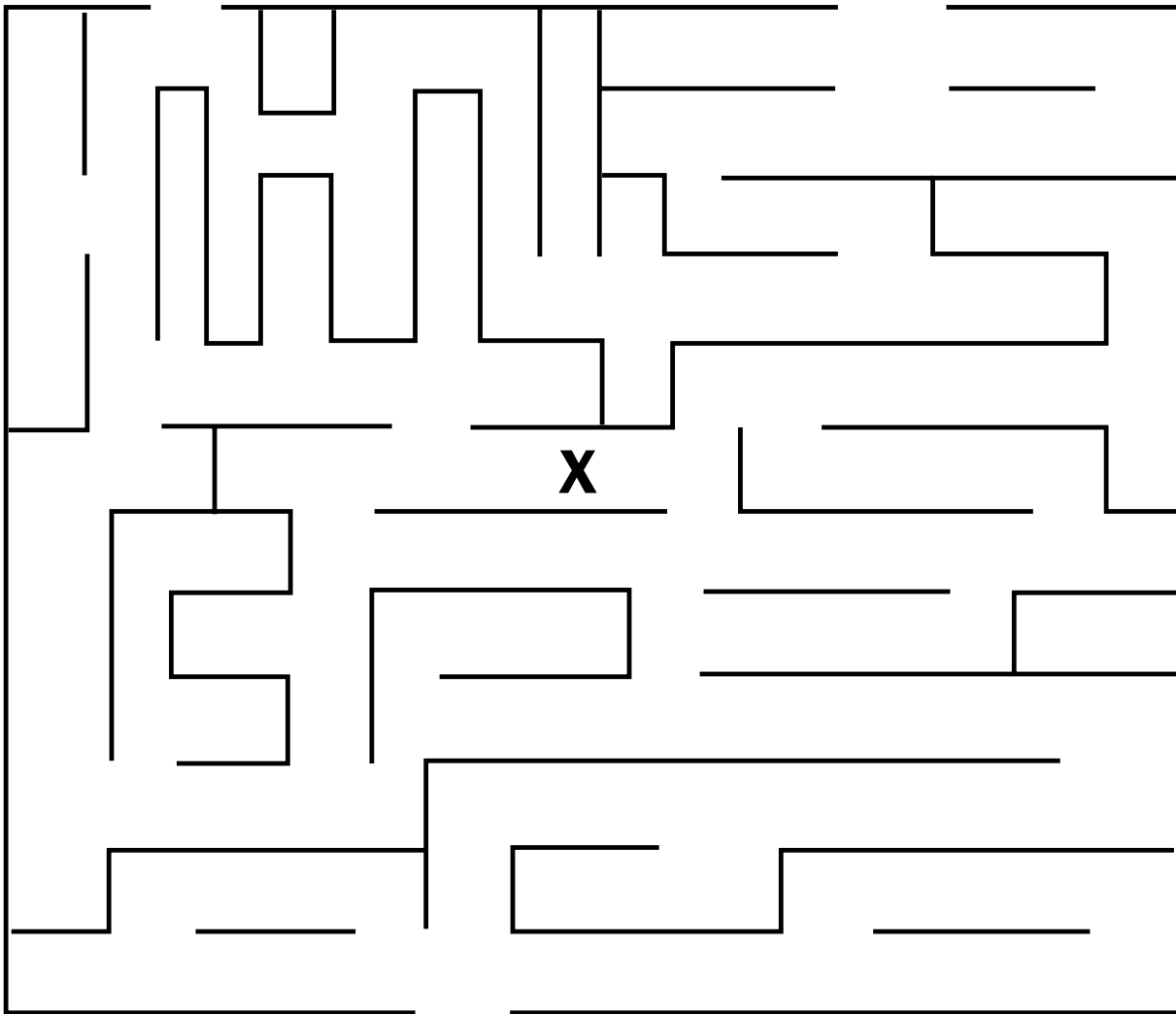
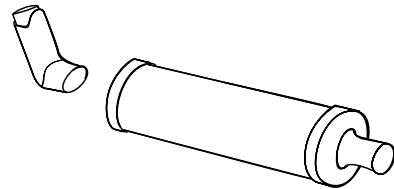
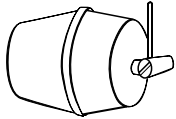
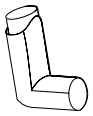

## Using an MDI with spacer

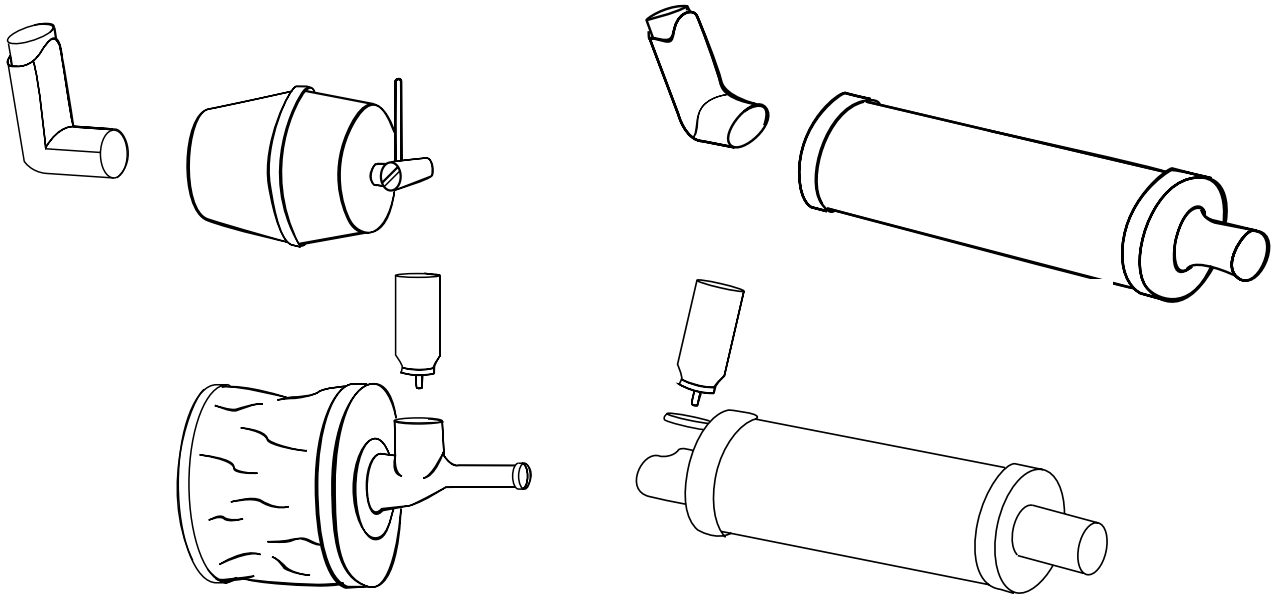

1. Put the MDI and empty spacer together.
2. Shake vigorously.
3. Practice breathing - breathe in deeply, breathe out normally.
4. Seal lips around spacer mouthpiece (1/2 inch in your mouth).
5. Push down on the MDI. Breathe in slowly and deeply while keeping your mouth on the spacer mouthpiece.
6. Hold your breath and count to 10 (in your head) while keeping your mouth off the spacer mouthpiece and breathe out.
7. Wait one minute, then repeat steps 1-6 for each puff you need.
8. Practice in front of a mirror.

\* If you see white mist coming out of your nose or mouth, you didn't do it right.

**Consult your doctor on the number of puffs you need of your prescribed medicine.**

# Other asthma equipment

If you use any of these, your doctor will help you learn how to use and take care of them.

Q: What is a nebulizer?

- Lets you take asthma medicine in the form of a mist.
- It has a cup used with a mask or mouthpiece that attaches to a tube from the nebulizer.
- The cup, tubing and mask or mouthpiece must be rinsed after each use and hung to dry.
- The filter must be changed when it turns gray.
- The cup must be replaced if it cracks. Unplug nebulizer when not in use.

Q: What is a breathing mask?

- Can be fitted onto the mouthpiece of a spacer.
- Helps you take as much of the medicine as possible.
- Comes in different sizes (small, medium and large).

